

Modellname:  
Nazwa modelu:

**LA NOTTE**

Modellreihe:  
Nr. modelu

**P8--LN**

Type:  
Typ: **Typ 02**

Blatt Nr  
Strona **2** von: **13**  
z:

**Nr 1**

**T6**  x16

**M1**  x12

**T1**  12

**C2**  x12

**B1**   $\phi$  8x28 x28

**B2**   $\phi$  10x35 x4

**K1**  7x50 x8

**C1**   $\phi$  2 x8

**W1**  x24

**Nr 2**

**M6**  x12

**P16**  3,5x13 x12

**L4**  x4

**Nr 3**

**F7**  x4

**S12**  3,5x13 x4

**Nr 4**

**A1**  x2

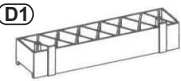
**D1**  x2

**Z1**  x1

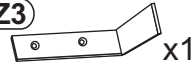
**Z3**  x1

**G1**  x2

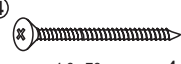
**S4**  4,0 x70 x4

**E3**  6,3x13 x4

**Nr 5**

**E9**  x1

**E11**  x1

**E5**  x1

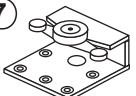
**E7**  x2

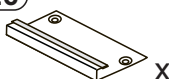
**E6**  x2

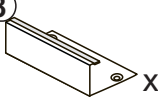
**E8**  x2

**E1**  6,3x11 x24

**Nr 6**

**L1**  Leim x2

**S3**  3,5x13 x7

**S14**  4x60 x11

**Nr 7**

**P13**  3,5x13 mm x4

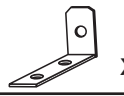

**J11**  x2

**J23**  x1

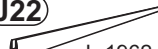
**J20**  L-650 x2

**J22**  L-1962 x2

**S100**  L=2019 mm x2

**A1**    x2

**POI**  x2

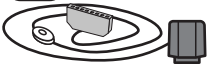





**O21**  x1

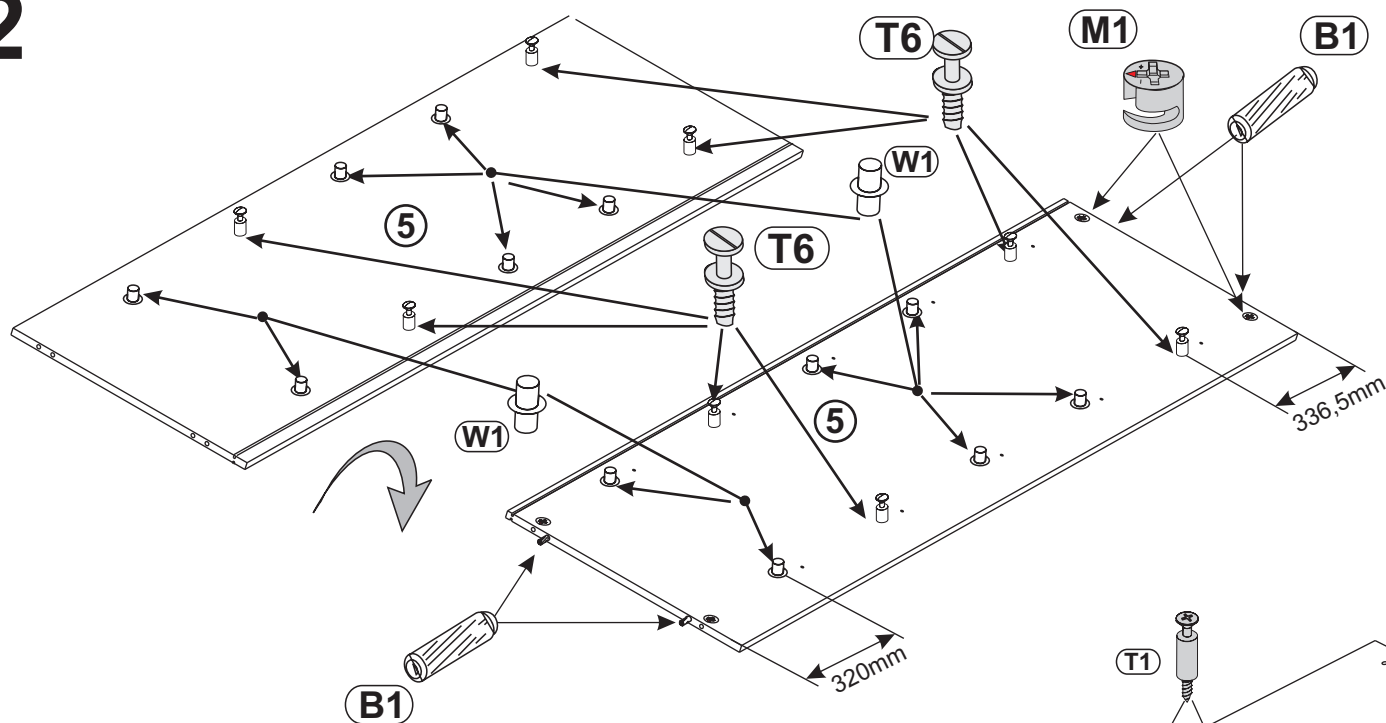



**2**





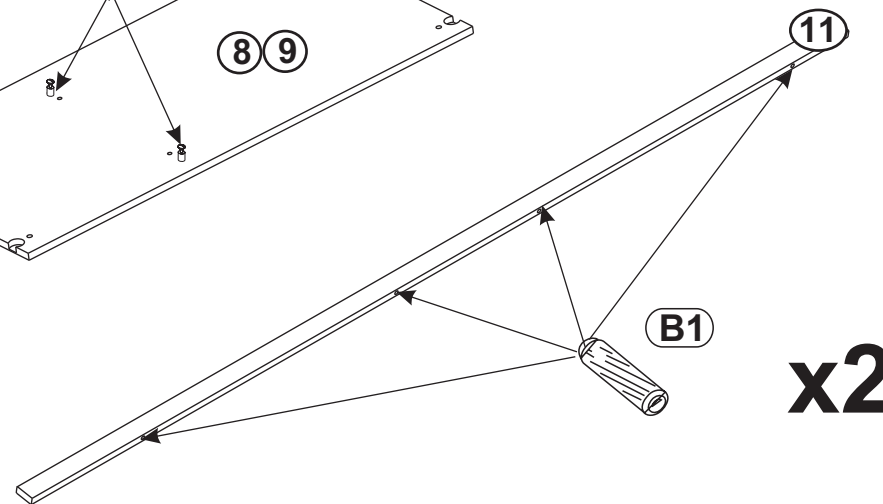
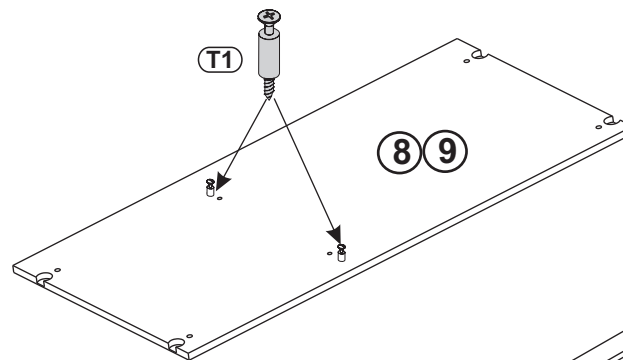
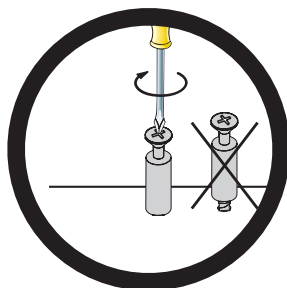
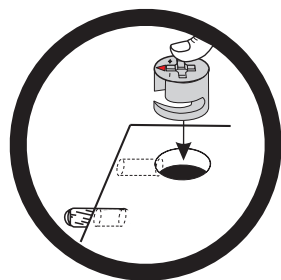
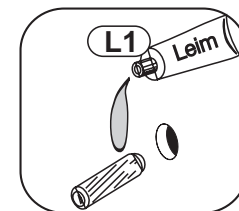

<b>T6</b>  x8	<b>B1</b>  $\phi$ 8x28 x12
<b>T1</b>  x4	<b>M1</b>  x4
	<b>W1</b>  x12
	<b>L1</b>  x2

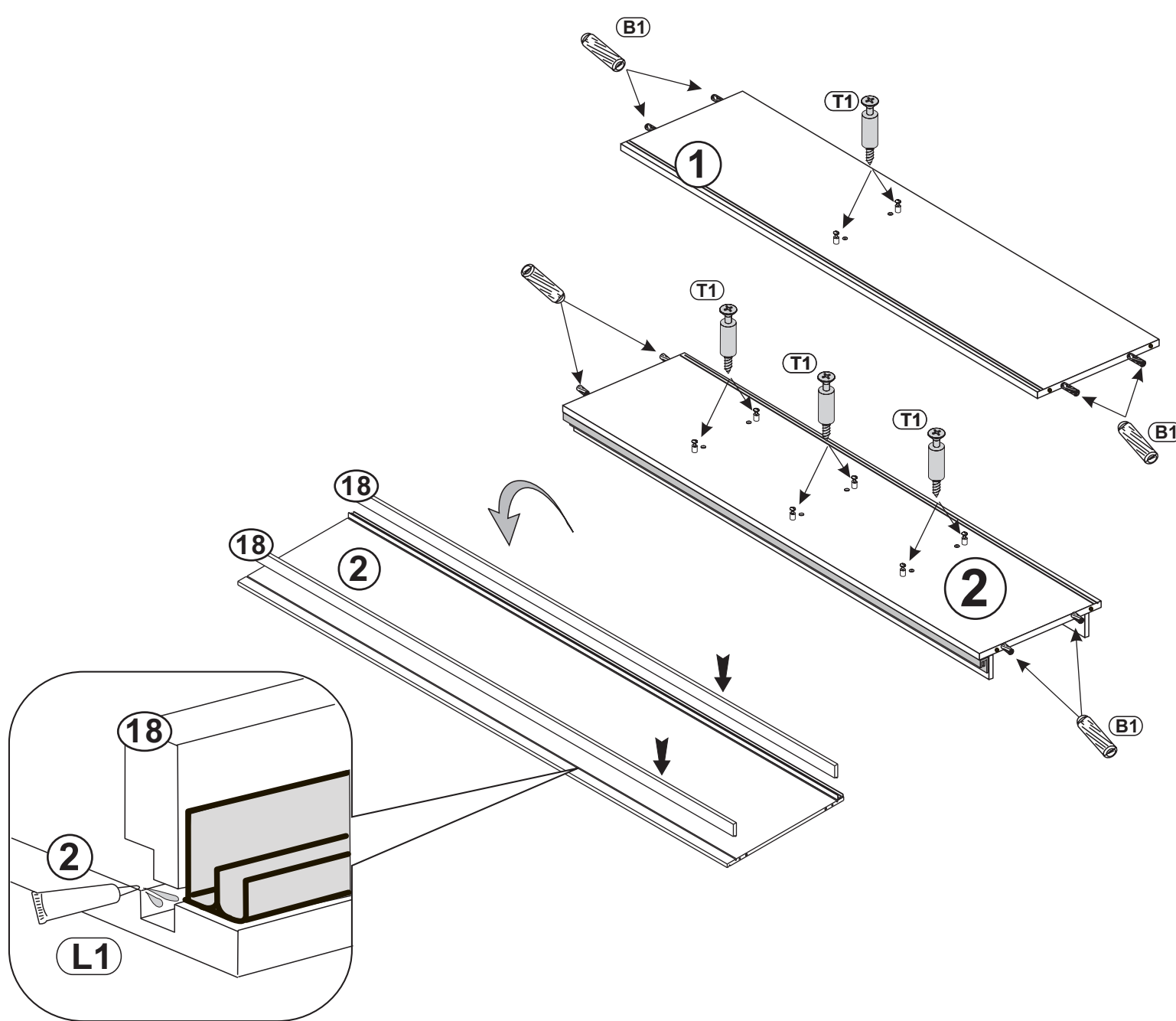

**x2**

**3**



- (T1)**  x8
- (B1)**   $\phi$  8x28 x8
- (L1)**  Leim x2

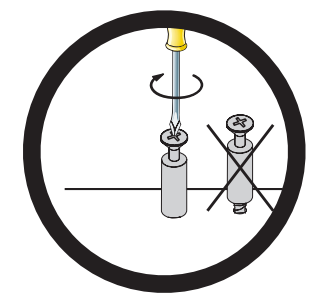

Modellname:  
Nazwa modelu:

**LA NOTTE**

Modellreihe:  
Nr. modelu

**P8--LN**

Type:  
Typ: **Typ 02**

Blatt Nr  
Strona **6**

von:  
z: **13**

**4**

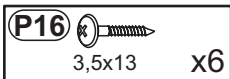
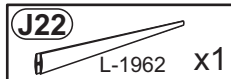
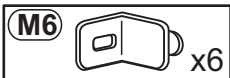
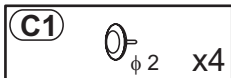
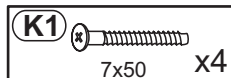
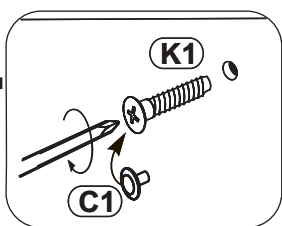

**5**

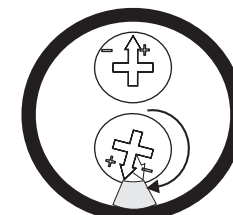
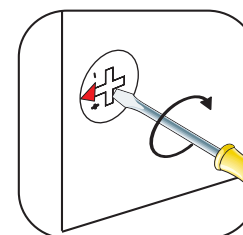
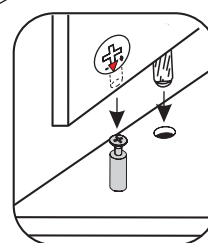
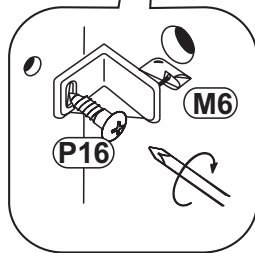
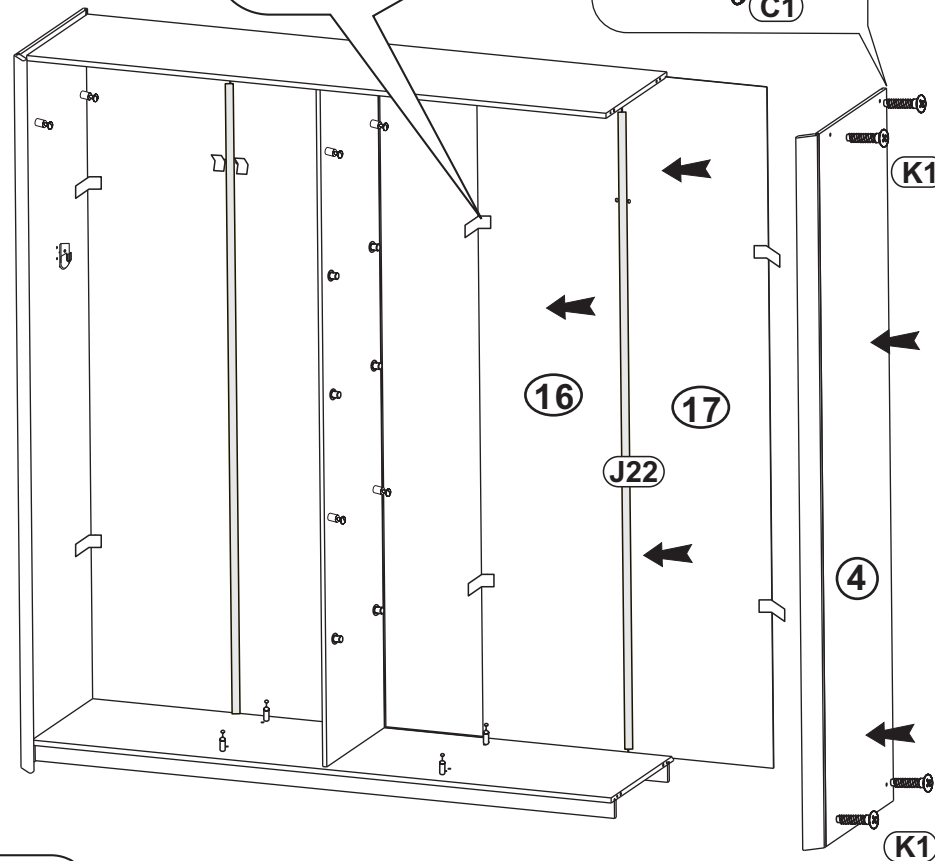
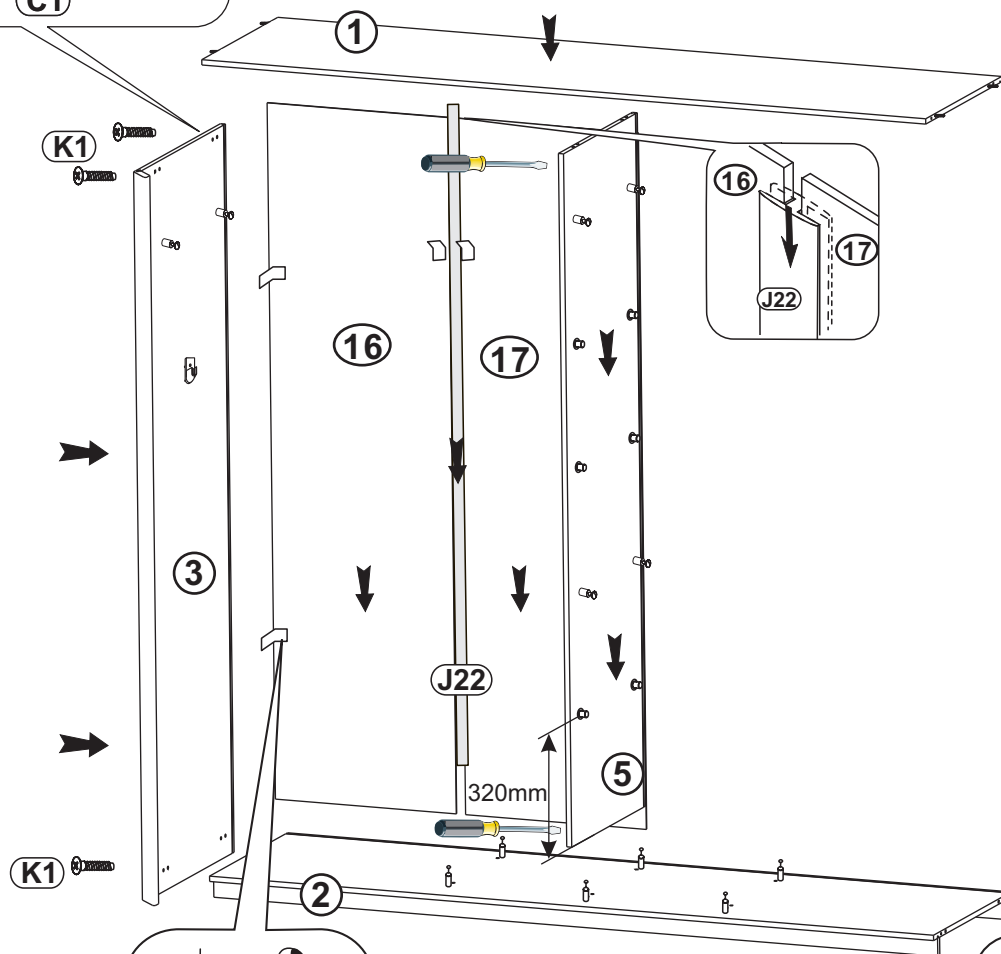
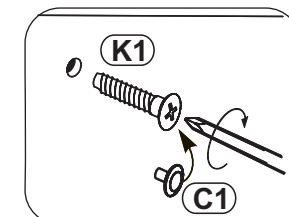
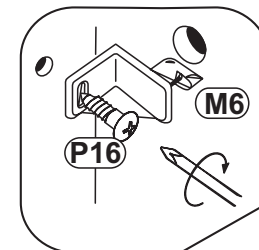
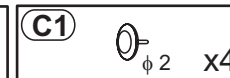
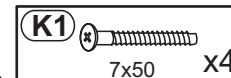
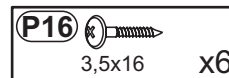

**6**

<b>J20</b>  L-650 x2	<b>C2</b>  x12
---	---

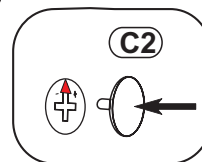
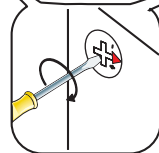
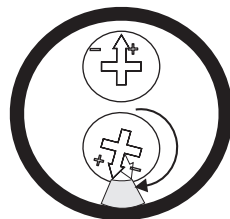
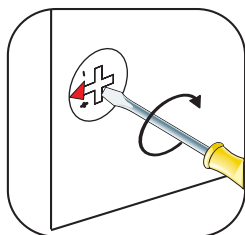
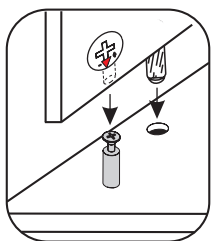
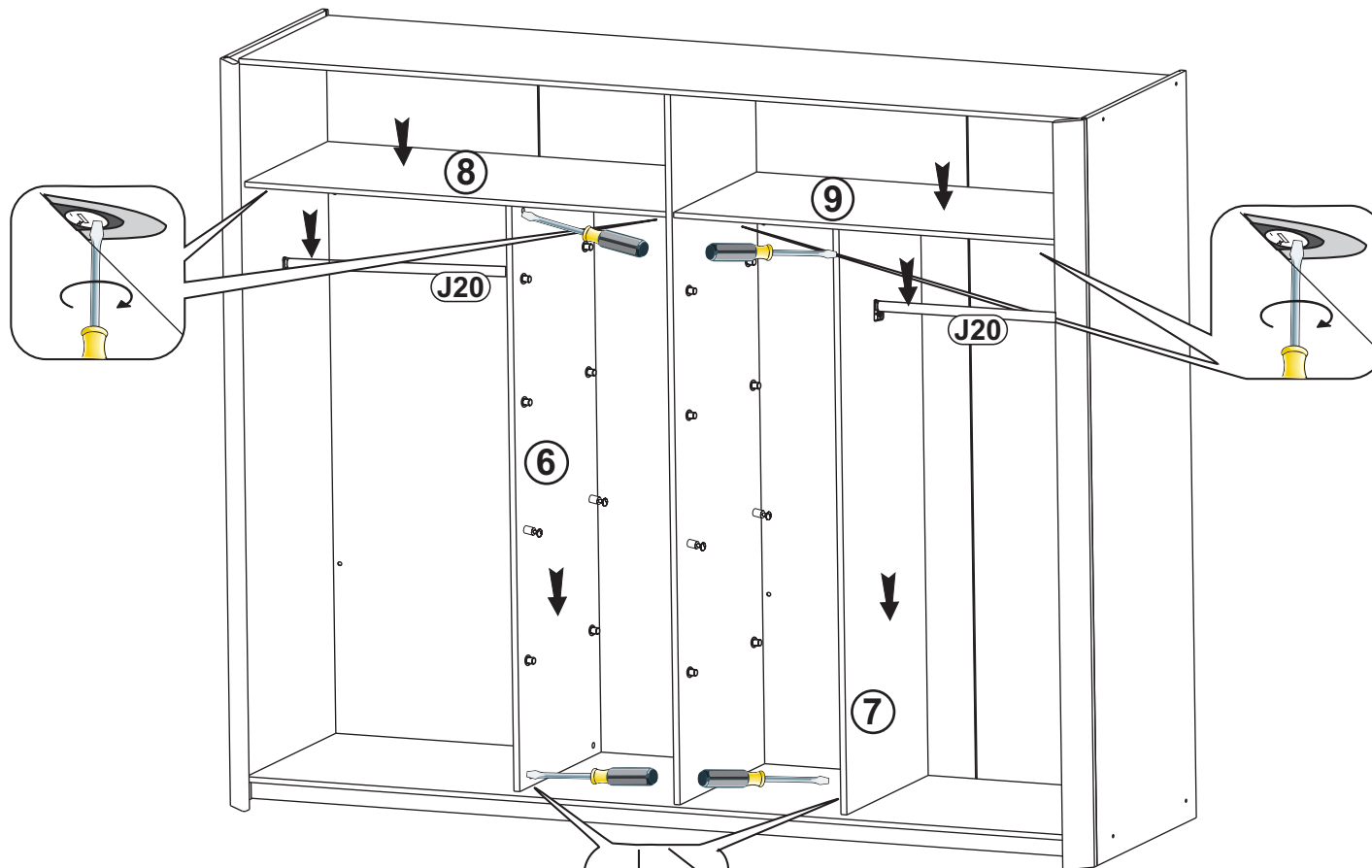

# 7

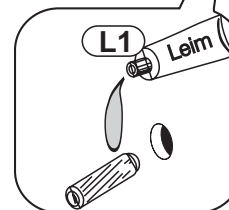
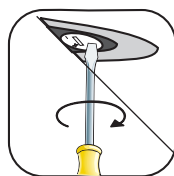
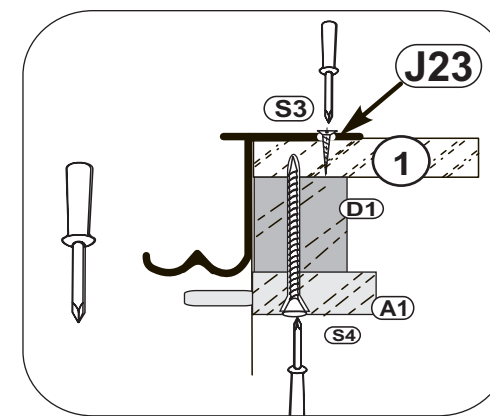
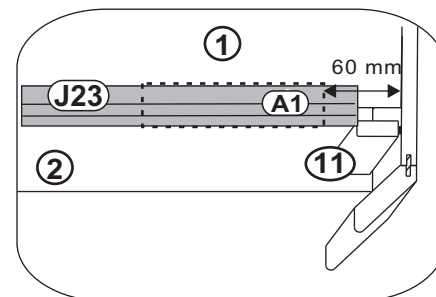
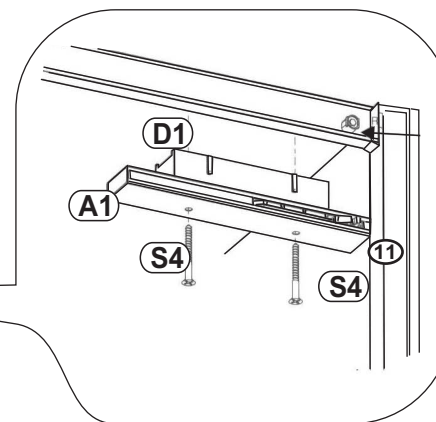
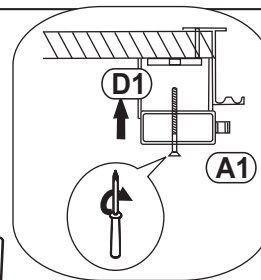
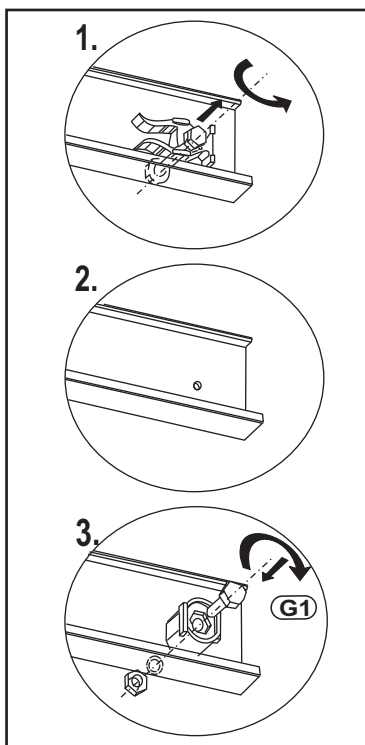
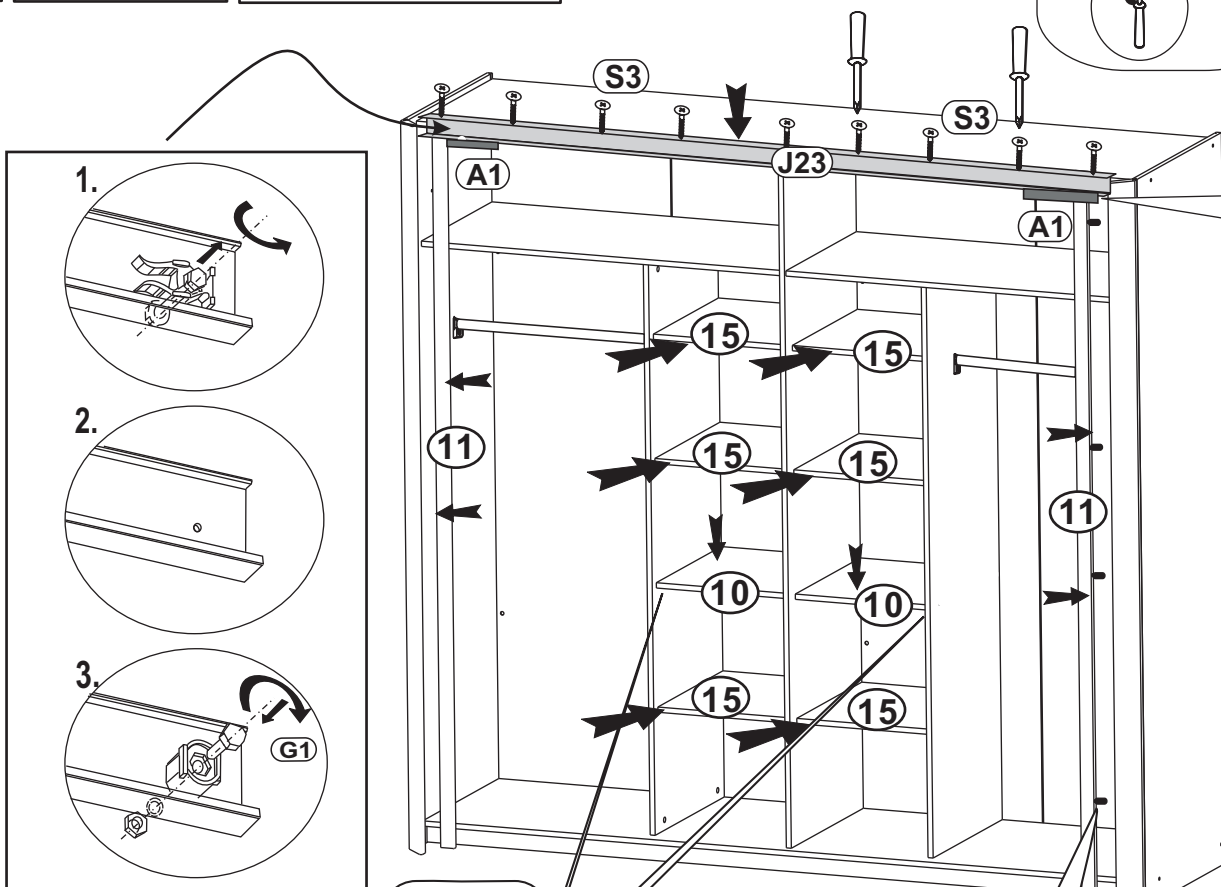
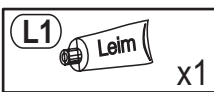
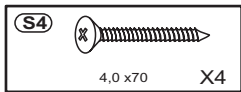
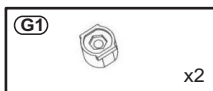
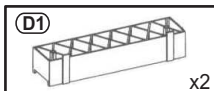
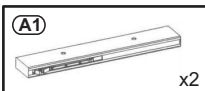



Modellname:  
Nazwa modelu:

**LA NOTTE**

Modellreihe:  
Nr. modelu

**P8--LN**

Type:  
Typ: **Typ 02**

Blatt Nr  
Strona **9** von:  
z: **13**

**8**

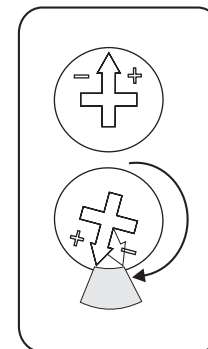
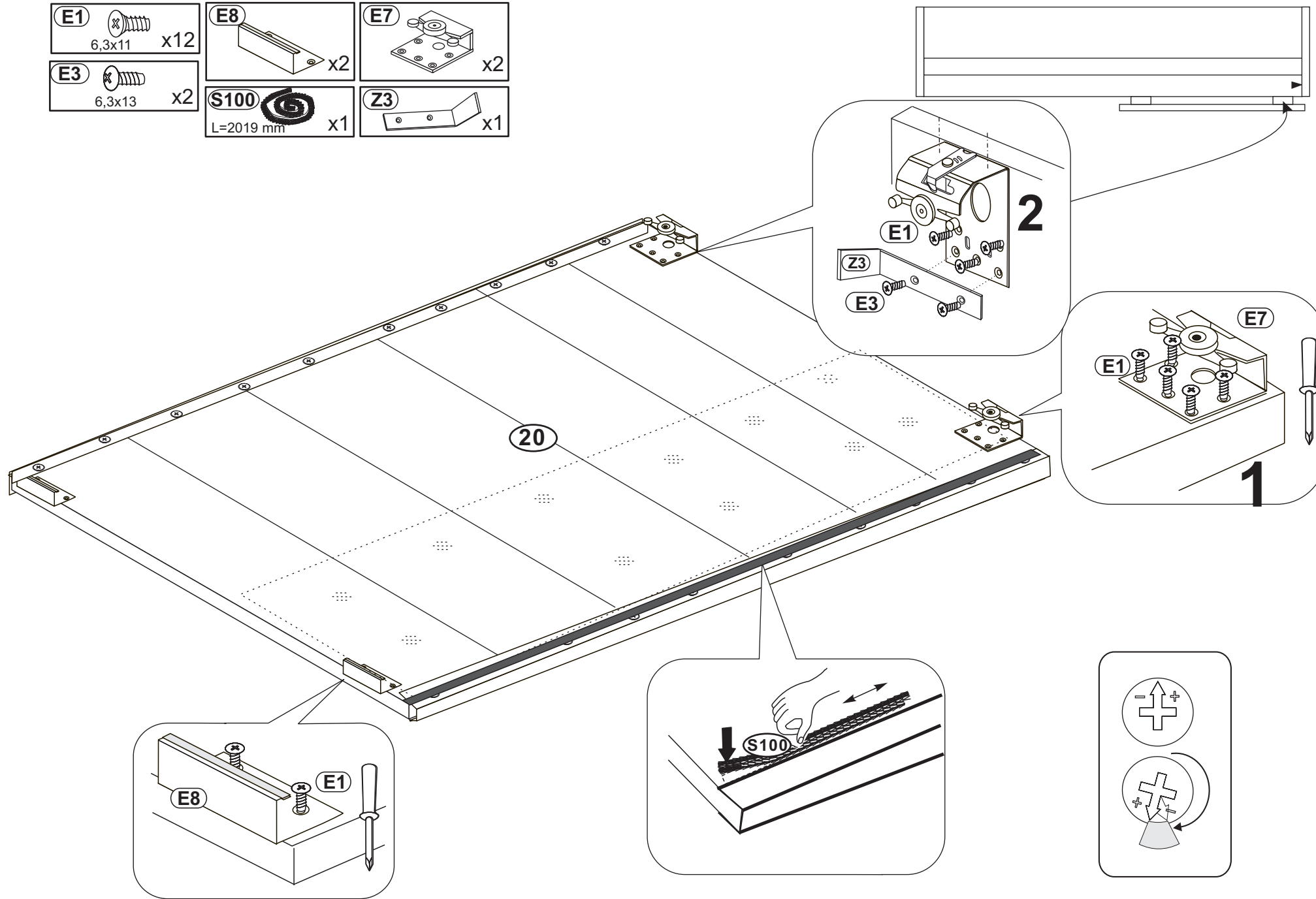
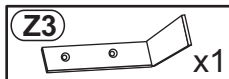
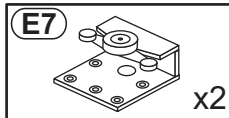
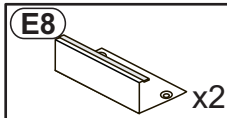
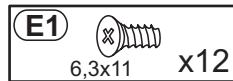

# 9

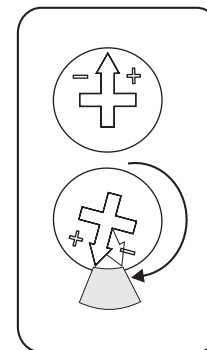
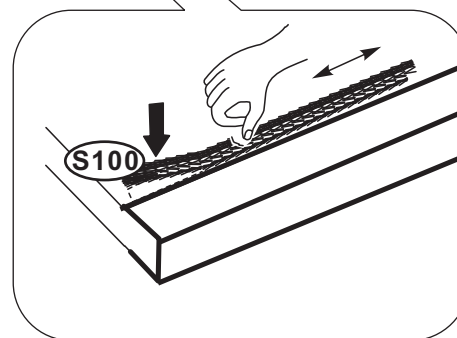
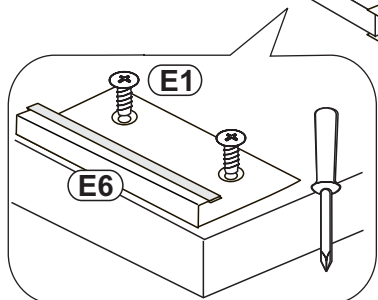
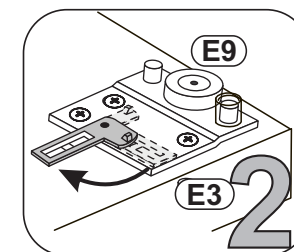
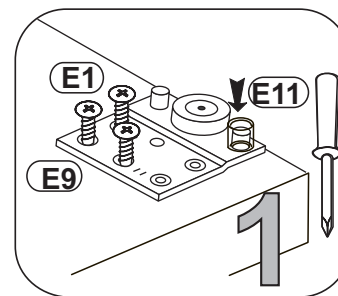
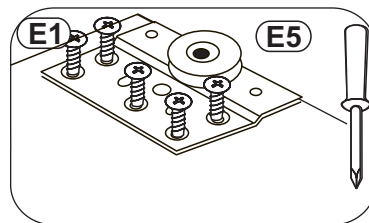
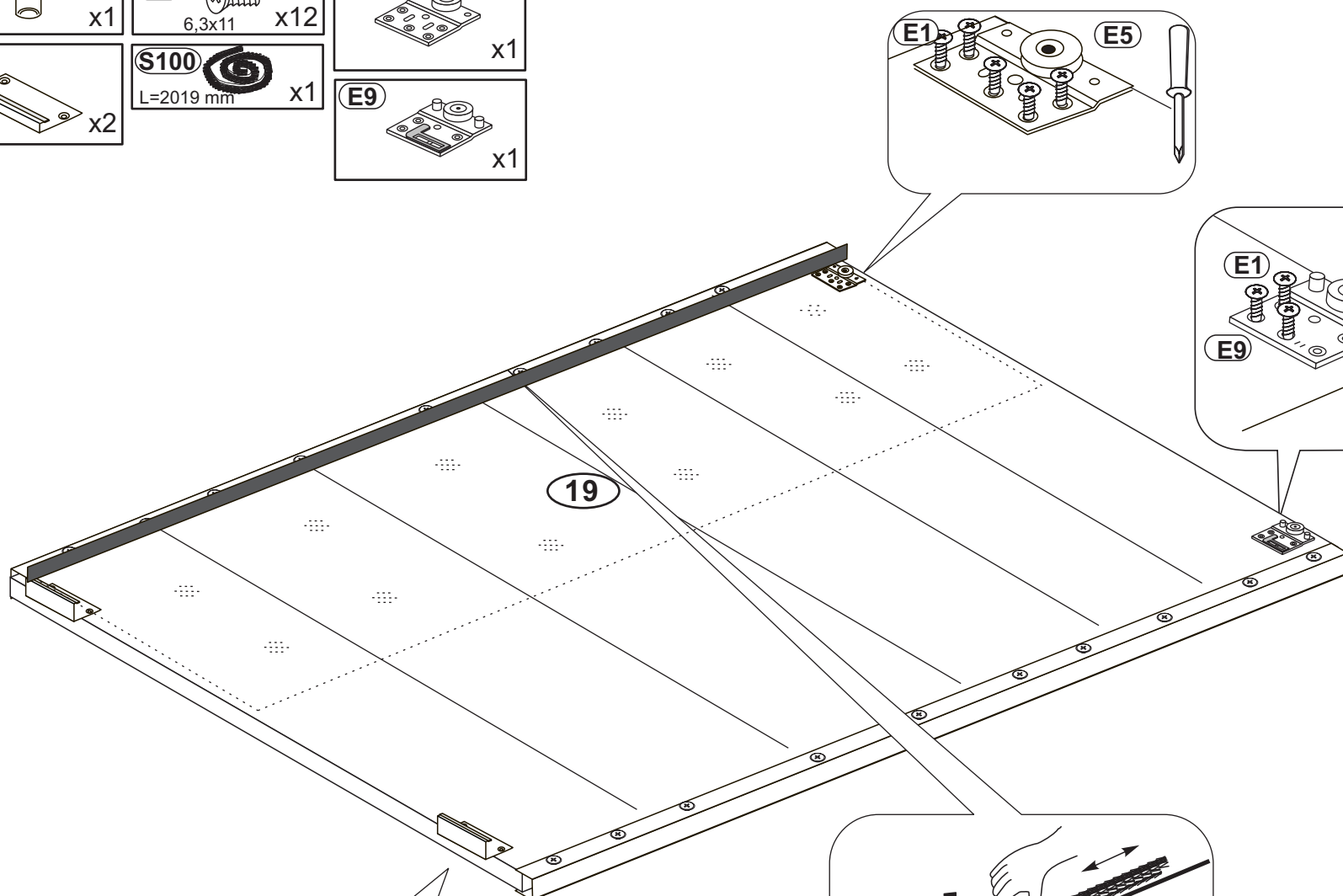
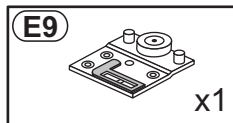
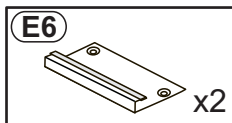
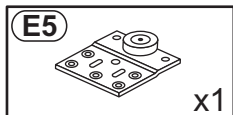
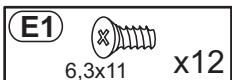
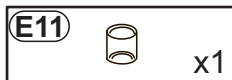

**10**

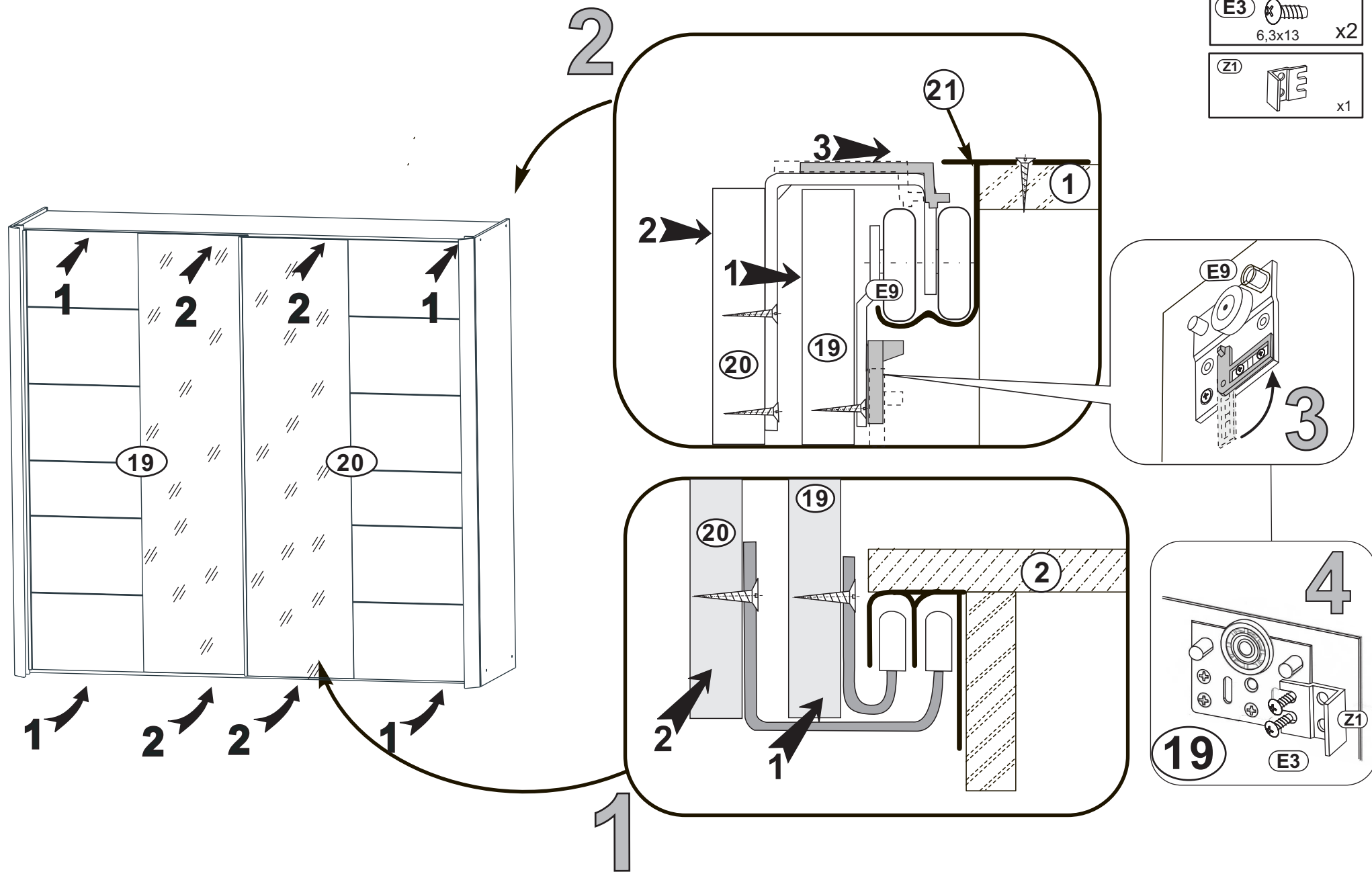

**11**

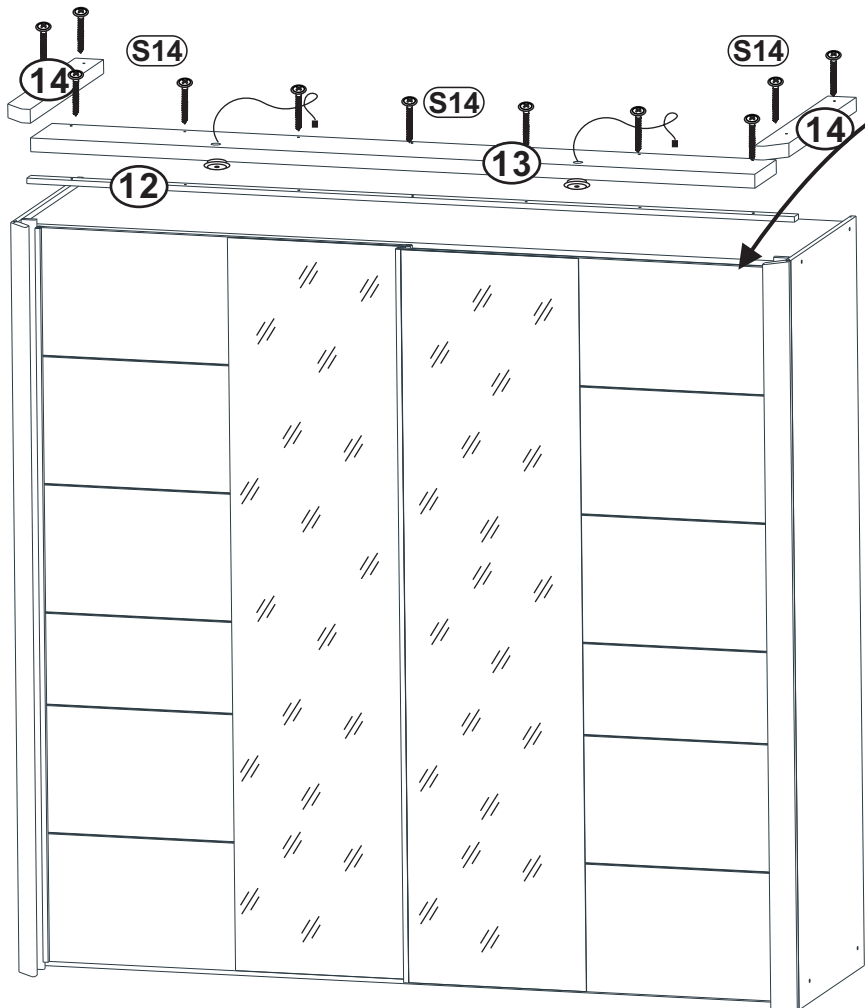
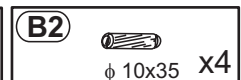
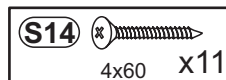
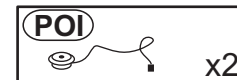

**2**

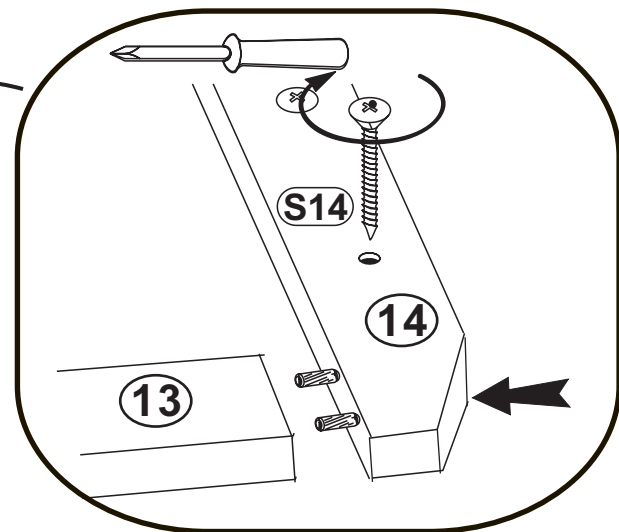

**1**

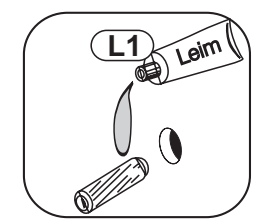
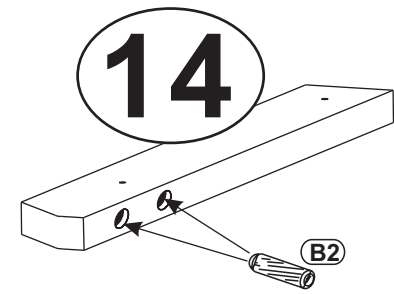
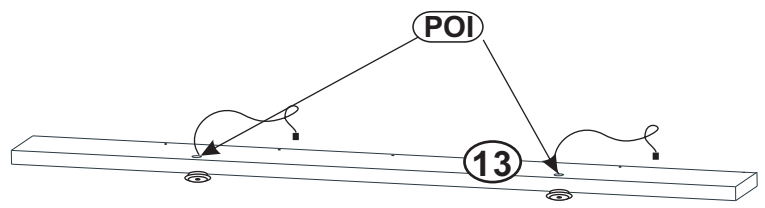

**12**

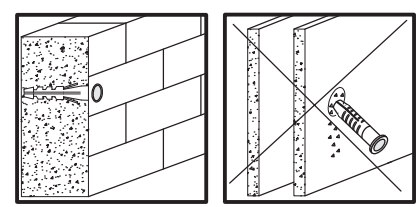
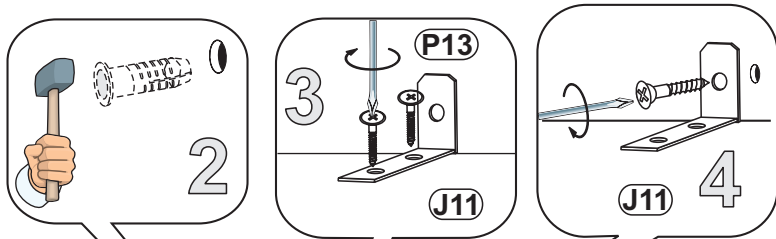
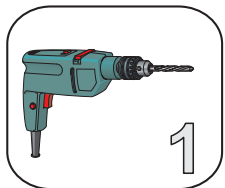

- L4** x2
- J11** x2
- P13** 3,5x13 mm x4
- O21** x1

